

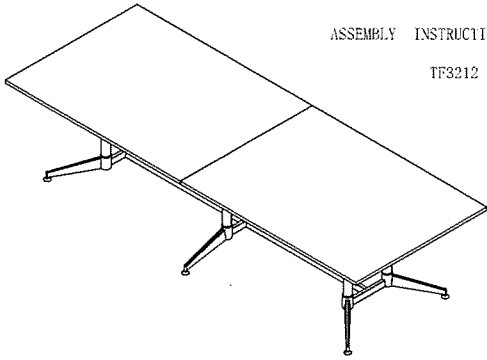





ASSEMBLY INSTRUCTIONS

TF3212



	M8x16H 48pcs
	M8x20H 26pcs
	M12 1pcs
	M6 1pcs
	M6 1pcs
	ø16 1pcs

①

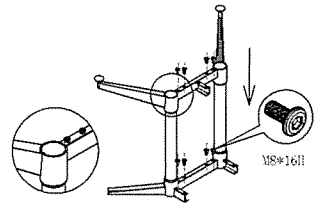

Slide Both The Bottom And Top Cross Bar Into The Left & Right Hand Side End Uprights - Attach Cross Bars With M8 Bolts (Do Not Completely Tighten Bolts)

②

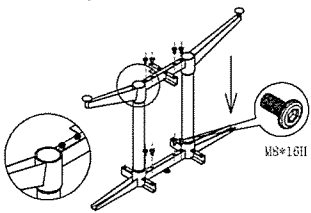

Slide Both The Bottom And Top Cross Bar Into The Central Uprights - Attach Cross Bars With M8 Bolts (Do Not Completely Tighten Bolts)

③

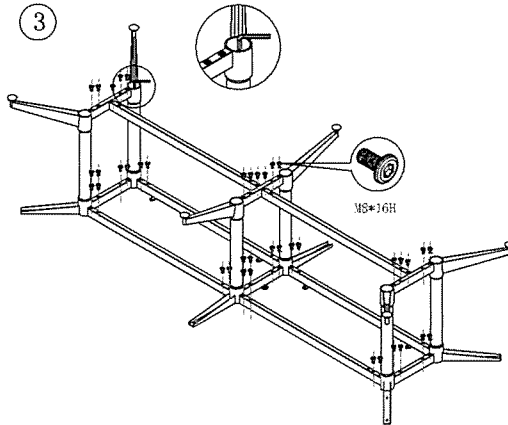

Layout Left, Right and Central Leg Upside Down On a Flat Surface. Slide Central Support Beams Into Legs - Attach Support Beams With M8 Bolts (Do Not Completely Tighten Bolts) . Once The Frame Is Sitting Flush On the Flat Surface, Tighten All Bolts Completely.

④

