

Installation guide

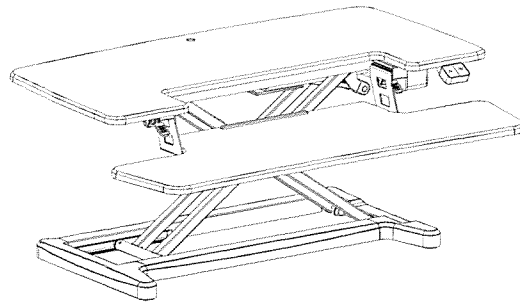
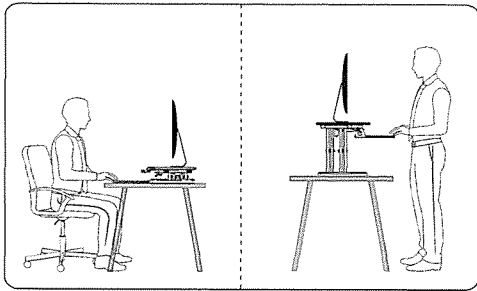

Technical Data

Table cover size:

MAX Max:25KG

MAX Max:2KG

>950mm

>610mm

120-505MM

375MM

700MM

308MM

415MM

950MM

Input Voltage: 100-240V

Max Loading Capacity: 25KG

Max Speed: 22mm/s

Height Range: 120-505mm(±5)

Temperature: 0-40°C

Frequency: 10%(Continuous operation for 2mins at most after pause for 18mins)

WARNING Please do not exceed the maximum WARNING bearing weight

STEP 1



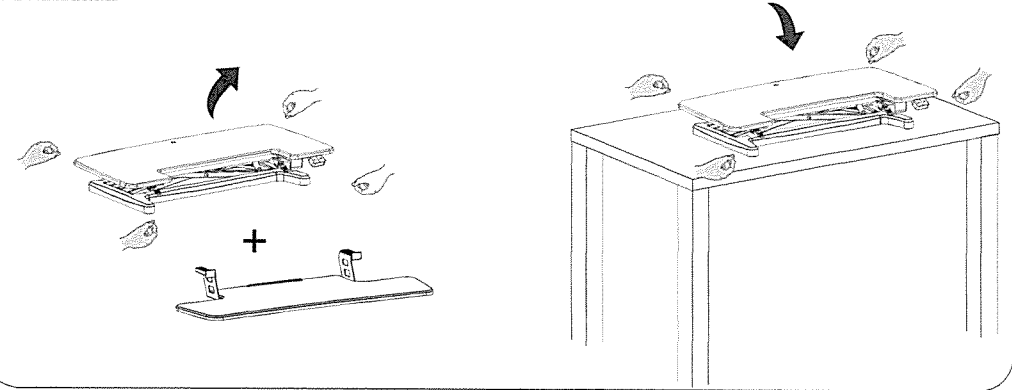

Only use the sit stand desk on top of flat and stable surface, strong enough to support the product and any equipment placed on top of it.

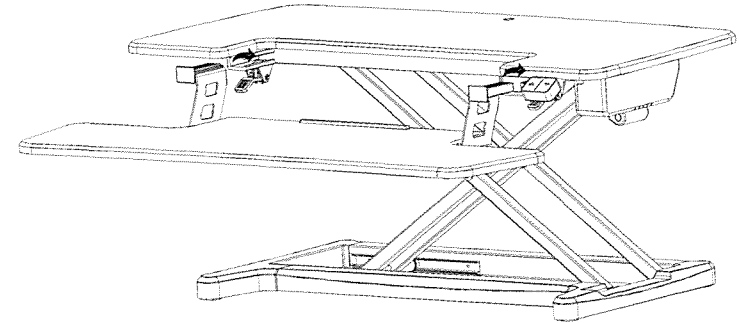

STEP 2

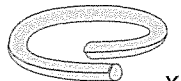

Accessory Package List

No.	Desktop Frame	No.	Keyboard Tray	No.	Cable Ties
A	 x1	B	 x1	C	 x4
No.	Cable Management	No.	Power Adapter	No.	Power Cable
D	 x1	E		F	

TOOLS



Hang the junction plate on the knob assembled and then tighten the Knob

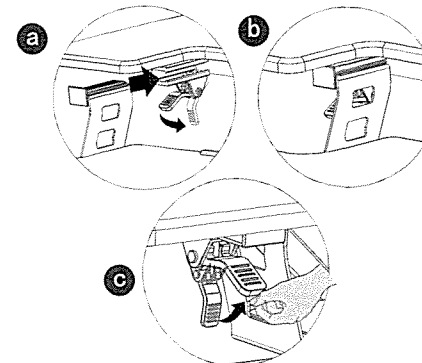

When removing the keyboard, please open the wrench and remove the keypad

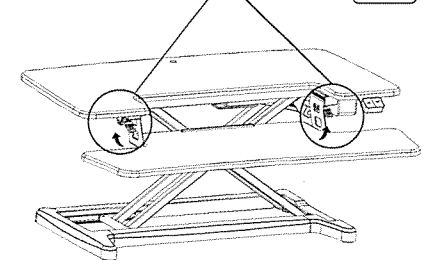

STEP 3

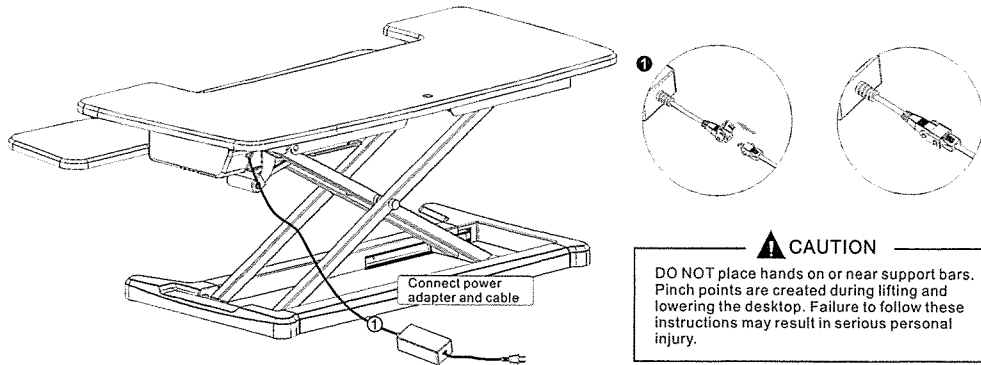

CAUTION

DO NOT place hands on or near support bars. Pinch points are created during lifting and lowering the desktop. Failure to follow these instructions may result in serious personal injury.

STEP 4

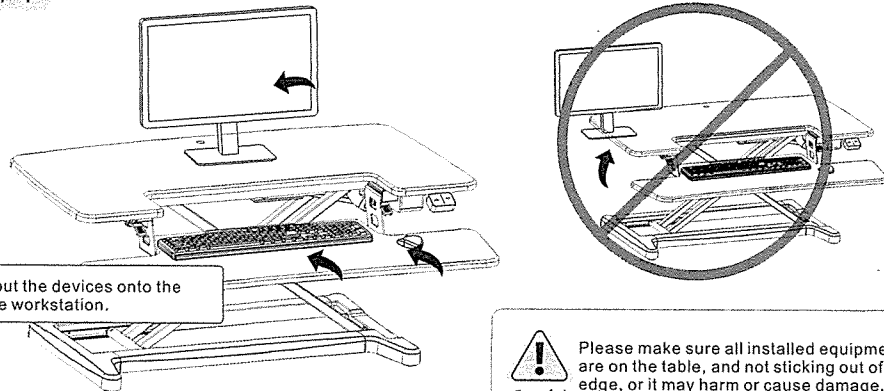

Please put the devices onto the top of the workstation.



Careful Please make sure all installed equipments are on the table, and not sticking out of the edge, or it may harm or cause damage.

STEP 5

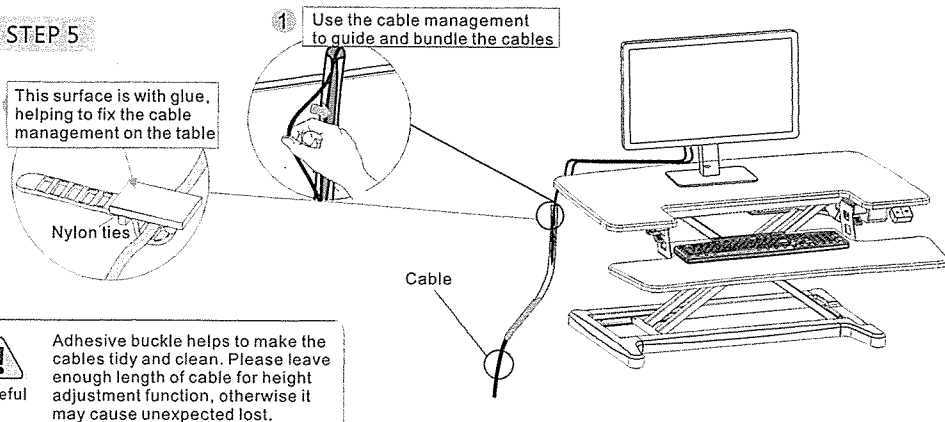

This surface is with glue, helping to fix the cable management on the table

Nylon ties

Cable



Adhesive buckle helps to make the cables tidy and clean. Please leave enough length of cable for height adjustment function, otherwise it may cause unexpected lost.

How to use handswitch

●	▲	Adjust the desk upwards
●	▼	Adjust the desk downwards

Button

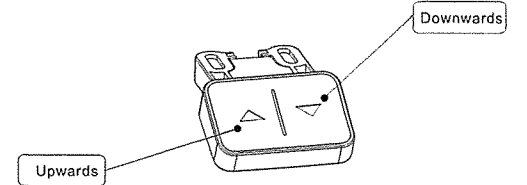

Attention

1. Power supply: AC100V-240V,50/60HZ
2. Service Environment: 0-40°C
3. Unplug the power plug before cleaning, wipe the dust on surface with slight wet dishcloth when cleaning, be careful not to let the drops into the internal parts, not loose the connector.
4. The electric box contains electronic components, metals, plastics, wires etc., so dispose of it in accordance with each country's environmental legislation, not the general household waste.
5. Check carefully to ensure correct and complete assembly before using.
6. Be familiar with all functions and program settings of the product before first use.
7. Children are forbidden to play on the product because of unforeseen action when playing, so any dangerous consequences caused by this improper action will not be on.
8. Slight noise caused by the V-ribbed belt or brake system due to structure will not have any effect on the use of the equipment.
9. Corrosive or abrasive materials are forbidden to clean the equipment. Must ensure that the cleaner used will not pollute the environment.
10. This appliance can be used by children aged from 8 years and above and persons with reduced physical, sensory or mental capabilities or lack of experience and knowledge if they have been given supervision or instruction concerning use of the appliance in a safe way and understand the hazards involved. Children shall not play with the appliance.
11. Cleaning and user maintenance shall not be made by children without supervision.
12. If the supply cord is damaged, it must be replaced by the manufacturer, its service agent or a similarly qualified person in order to avoid a hazard.
13. Please make sure there is no hazard sources in your operating environment, e.g., do not litter the litters around. Always be careful to treat the packaging materials in order to avoid any possible danger, e.g. plastic bag may lead to choking hazard to children.
14. Keep the original package of the equipment if necessary in case of the future use in transportation.

Common fault treatment

The following tips will help you detected and eliminate the common fault and error. If the fault you met is not listed below, please contact with your supplier. Only the manufacturer and professionals are capable for investigating and correcting those fault and error.

Fault Phenomenon	Method
No response while long pressing down/up button after connected with power supply	1. Check if all the cables be connected well 2. Contact your supplier or dealer
Downward sliding	1. Check if overloaded, Max loading :25kg 2. Contact your supplier or dealer
Overwork (Duty cycle: Max 2min on / 18min off)	1. Restart after suspend for 30mins 2. Contact your supplier or dealer

Waste disposal



This marking indicates that this product should not be disposed with other household wastes. To prevent possible harm to the environment or human health from uncontrolled waste disposal, recycle it responsibly to promote the sustainable reuse of material resources. To return your used device, please use the return and collection systems or contact the retailer where the product was purchased. They can take this product for environmental safe recycling.

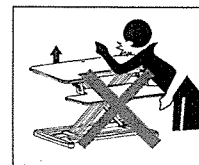

Attention Please first adjust it to the highest, then remove equipment to avoid harm or damage.

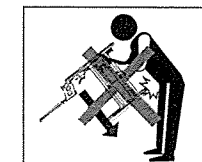

Attention Please move it by two persons, or parts may collide and cause damage.